

# Indholdsfortegnelse

## Afsnit 4: Staldteknik

Dele:	Type:	Side:
Trækstation	<i>Trækstation for kæde transport</i>	4 - 1
Kæde transport	<i>Tilbehør</i>	4 - 2
Transportkæde		4 - 3
Wiretransport	<i>For 60mm rør</i>	4 - 5
Påslagstragte	<i>For 60mm rør</i>	4 - 6
Rør & samlemuffer		4 - 8
Inspektionsrør & hjørner		4 - 9
Udløb		4 - 11
Sensorer		4 - 12
Foderkasser		4 - 13
Foderkasser	<i>Med fiksering</i>	4 - 15
Fikseringskæde m.m		4 - 16
Centrifugalpumper	<i>FLEX rustfri</i>	4 - 17
Reservedels Tegning	<i>FLEX centrifugalpumper</i>	4 - 18
Reservedele	<i>FLEX Pumpe Dele</i>	4 - 19
Reservedele	<i>FLEX Pumpe Dele</i>	4 - 20
Gearmotorer / Pumper	<i>Excentersnekkepumper</i>	4 - 21
Reservedele	<i>NETZSCH M038BY01L06B</i>	4 - 22
Reservedele	<i>NETZSCH NM0045</i>	4 - 23
Reservedele	<i>NETZSCH NM045BY og NM045SY</i>	4 - 24-1
Reservedele	<i>NETZSCH NX 300 og NX 417</i>	4 - 24-7
Reservedele	<i>SEEPEX 17 - 6L Pumpe</i>	4 - 25
Pumper	<i>WANGEN BD 50</i>	4 - 26
Gearmotorer / Pumper	<i>Excentersnekkepumper</i>	4 - 26
Reservedele	<i>WANGEN BD 50</i>	4 - 27
Reservedels Tegning	<i>WANGEN BD 50 Tegning</i>	4 - 29
Reservedele	<i>WANGEN KL 30S 6.0</i>	4 - 29-1
Reservedels Tegning	<i>WANGEN KL 30S 6.0 Tegning</i>	4 - 29-3
Reservedele	<i>WANGEN KL 30S 6.0 Mellearhus</i>	4 - 29-4
Reservedels Tegning	<i>WANGEN KL 30S 6.0 Mellearhus Tegning</i>	4 - 29-6
PVC dele	<i>Union, Vinkel</i>	4 - 30
	<i>Bøjning</i>	4 - 31
	<i>Y-stykke, T-styk</i>	4 - 32
	<i>Kryds</i>	4 - 33
	<i>Overgangsnippel/studs, Slutmuffe, Muffe</i>	4 - 34
	<i>Red. Muffe, Red. Ring, Trykrør</i>	4 - 35
	<i>Kuglehane, Kontraventil</i>	4 - 36
	<i>PVC Lim, Sprinkler</i>	4 - 37
Membraner	<i>Vådfodringsanlæg</i>	4 - 39-1
Magnetventiler	<i>Foderventiler</i>	4 - 40-1
Magnetventiler	<i>Vandventiler</i>	4 - 40-3
Skråsådeventil	<i>Sektionsventiler</i>	4 - 41-1
Magnetventiler & Fittings	<i>T-forskruning, Samlestykke</i>	4 - 42
Magnetventiler & Fittings	<i>Overgangsnippel, Nylon pakning, Slange</i>	4 - 43
Membranventiler	<i>Flexventiler</i>	4 - 44-1
Varmelamper / Varmepærer		4 - 45



## Trækstation for kæde transport for rør Ø60mm

Varegruppe 405

<i>Model.</i>	<i>Beskrivelse.</i>	<i>Vare nr.</i>
	Trækstation TC rustfri stål, 0,75 kW gearmotor 0,75 kW, 380 V elektromekanisk sikkerhedskontakt, vægt 62 Kg	602304
	Trækstation TC rustfri stål, 0,75 kW med sikkerhedsstift (safety device ) gearmotor 0,75 kW, 380 V elektromekanisk sikkerhedskontakt, sikkerhedsstift vægt 62 Kg	602355
	Trækstation TC rustfri stål, 1,5 kW gearmotor 1,5 kW, 380 V elektromekanisk sikkerhedskontakt, vægt 62 Kg	601304
	Trækstation TC rustfri stål, 1,5 kW med sikkerhedsstift (safety device ) gearmotor 1,5 kW, 380 V elektromekanisk sikkerhedskontakt, sikkerhedsstift vægt 62 Kg	601354
	Trækstation TC rustfri stål, 1,5 kW med fyldetragt elektromekanisk sikkerhedskontakt, sikkerhedsstift vægt 80 Kg	600304
	Trækstation SUPER rustfrit stål, 1,85 kW med sikkerhedsstift (safety device ) gearmotor 1,85 kW, 380 V elektromekanisk sikkerhedskontakt, sikkerhedsstift op til 800 m transportsystem ( incl. hjørner)	601306
Til transportsystem Ø 50mm eller 45mm skal der anvendes 2 reduktionsstykker pr. trækstation !		





## Kæde transport tilbehør

Varegruppe 405

Model.	Beskrivelse.	Vare nr.
	Reduktionsstykke galv. fra Ø60 mm til Ø45mm	451010
	Reduktionssykke galv. fra Ø60mm til Ø50mm	800050
	Sikkerhedsstift for SUPER-trækstation	601306-43
	Sikkerhedsstift for trækstation	815159
	Beskyttelsesskærm for gearmotor på trækstation, rustfri stål, uden bolte	600990
	Beskyttelsesskærm for gearmotor på trækstation med fyldetragt, rustfrit stål	600991
	Returløbsrør til fyldtragt på 600304 rustfrit stål Længde: 110mm Ø76mm.	600994
	Beskyttelsesskærm for trækstation Polyester Højde: 635mm. Bredde: 1000x396mm. Vægt: 13 kg.	601000
	Monteringsbeslag for trækstation rustfrit stål Højde: 430mm. Bredde: 880x400mm. Vægt: 5,5 kg.	601900

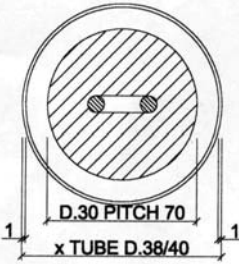
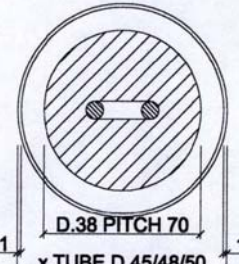
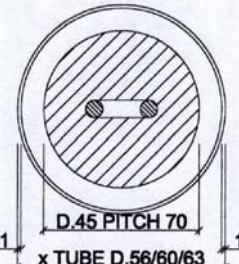



## Transportkæde

Varegruppe 405

Model.	Beskrivelse.	Vare nr.
	Transportkæde, galvaniseret for Ø38mm rør  Medbringerskive: Ø30mm afstand 70mm	387030
	Transportkæde galvaniseret  Medbringerskive: Ø38mm afstand 70mm	451110
	Transportkæde rustfrit stål for Ø45 mm rør  Medbringerskive: Ø38mm afstand 70mm	451120
	Transportkæde galvaniseret  Medbringersskive Ø45mm afstand 70mm	607042
	Transportkæde rustfrit stål for Ø60mm rør  Medbringersskive Ø45mm afstand 70mm	607043
	Kædesamleled galvaniseret for 70mm medbringerafstand 10 stk. pr. pose	607019
	Kædesamleled rustfrit stål for 70mm medbringerafstand 10 stk. pr. pose	607020
	Kæderne leveres i sække med 50 m/ 28kg.	

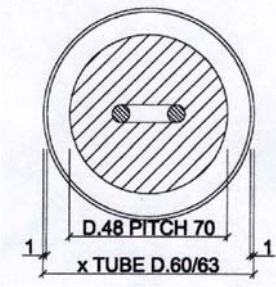
## Transportkæde

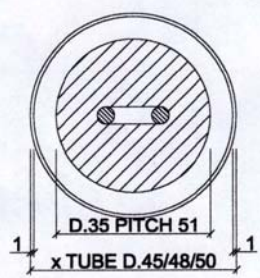
Varegruppe 405

Model.	Beskrivelse.	Vare nr.
	Transportkæde galvaniseret for Super trækstation for Ø60mm rør  Medbringerskive: Ø48mm afstand 70mm	607048
	Transportkæde rustfrit stål for Super trækstation for Ø60mm rør  Medbringerskive: Ø48mm afstand 70mm	607049
	Kæde samleled rustfrit stål for Super trækstation 70mm medbringer afstand 10 stk pr. pose	607021
	Transportkæde galvaniseret for Ø45mm rør  Medbringerskive: Ø35mm afstand 51mm	455135
	Kæde samleled galvaniseret 51mm medbringerafstand 10 stk pr. pose	455136
	Kæderne leveres i sække med 50 m/ 28kg.	

## Wiretransport for 60mm rør

Varegruppe 405

Model.	Beskrivelse.	Vare nr.
	Trækstation TC rustfri stål 1,1 kW for wire transport  gear motor 1,1 kW, 380 V elektromekanisk sikkerhedskontakt sikkerhedsstift Højde: 519mm Bredde: 1035mm	601665
	Sikkerhedsstift for trækstation	815159
	Wire galvaniseret Medbringerskive Ø48mm, Pitch 71,5mm Pakkeenhed: 250 m rulle	601662
	Wire rustfrit stål Medbringerskive Ø48mm Pitch 71,5mm Pakkeenhed: 250 m rulle	601664
	Wire samler galvaniseret for wire med pitch Ø48mm	601663
	Værktøj til wiresamler rustfrit stål	601661
	Rør forlænger for Ø60mm rør (for 2 stk.)	800663

## Påslagstragte for 60mm rør

Varegruppe 405

Model.	Beskrivelse.	Vare nr.
	<p>Påslagstragt 1 vejs rustfrit stål</p> <p>Højde: 345mm Bredde: 526mm x 355mm Vægt: 9 Kg</p>	603304
	<p>Påslagstragt 2 vejs rustfrit stål</p> <p>Højde: 345mm Bredde: 526mm x 365mm Vægt: 9 Kg</p>	604304
	<p>Påslagstragt med fødeapparat og flow måler</p> <p>gear motor 0,18 kW Højde: 445mm Bredde: 526mm x 365mm Vægt: 11 Kg</p>	603305
	<p>Beskyttelse for gearmotor på 603305, rustfrit stål</p> <p>Højde: 205mm Bredde: 180mm x 350mm Vægt: 3 Kg</p>	603308
	<p>Påslagstragt med kædetrukket snegl</p> <p>Højde: 395mm Bredde: 525mm x 525mm Vægt: 20 Kg</p>	603306



## Påslagstragte for 60mm rør

Varegruppe 405

Model.	Beskrivelse.	Vare nr.
	<p>Påslagstragt med kædetrukket snegl med reduceret stigning</p> <p>Højde: 395mm Bredde: 525mm x 525mm</p>	<p>603306-D</p>
	<p>Overløbsrør for påslagstragt 603306</p> <p>Ø76mm Vægt: 1 kg</p>	<p>603307</p>
	<p>Låg til ifyldningstragt, med skod</p> <p>Krave Ø275mm Vægt: 3 kg</p>	<p>200200</p>
<p>Til transportsystem Ø50mm eller 45mm rør anvendes 2 eller 4 reduktionsstykker pr. tragt !</p>		





## Rør og samlemuffer

Varegruppe 405

Model.	Beskrivelse.	Vare nr.
	Rør galvaniseret DIN 2394 70 x 1,50mm	818173
	Rør galvaniseret DIN 2394 60 x 1,25mm	818174
	Rør galvaniseret DIN 2394 50 x 1,50mm	818183
	Rør galvaniseret DIN 2394 45 x 1,25mm	818190
	Rør galvaniseret DIN 2394 38 x 1,00mm	818197
længder af 6 meter Leveres i bundter		
Andre rør dimensioner leveres efter forespørgsel		
	Rustfrit rør 60,3 x 1,25mm	605304
	Rustfrit rør 45 x 1,25mm	451030
Lev. efter forespørgsel		
	Rørsamlemuffe for Ø60mm rør	601400
	Rørsamlemuffe m/bolte for Ø60mm rør	601401
	Samlemuffe med bolte for Ø60mm rør	601300
	Samlemuffe med bolte for Ø60mm rør	607304
	Samlemuffe m/bolte for Ø50mm rør	501401
	Samlemuffe med bolte for Ø45mm rør	451051





## Inspektionsrør og hjørner

Varegruppe 405

Model.	Beskrivelse.	Vare nr.
	Inspektionsrør galvaniseret, delvis transparent for Ø60mm rør Længde: 515mm Vægt: 870 g	600200
	Inspektionsrør galvaniseret, transparent Længde: 495mm Vægt: 920 g	800102
	Inspektionsrør rustfrit stål, transparent Længde: 495mm Vægt: 880 g	800102-V2A
	Hjørne 90 gr. PVC med 2 lejer for Ø60mm rør Støbt jernhjul Rustfri bolte Vægt: 4,5 Kg	609200
	Hjørne 90 gr. PVC med 2 lejer for Ø60mm rør Polyethylen hjul Rustfri bolte Vægt: 4,5 Kg	609500

## Inspektionsrør og hjørner

Varegruppe 405

Model.	Beskrivelse.	Vare nr.
	Hjørne 90 gr. Aluminium med 2 lejer for Ø60mm rør Støbt jernhjul Rustfri bolte Vægt: 6,5 Kg	609300
	Hjørne 90 gr. PVC, GFK med 2 lejer for Ø60mm rør  Polyethylen-hjul Rustfri bolte Vægt: 3 Kg	802108
	Hjørne 90 gr. PVC, GFK med 2 lejer for Ø50mm rør  Polyethylen-hjul Rustfri bolte Vægt: 3 Kg	802179
	Hjørne 90 gr. PVC, GFK med 2 lejer for Ø45mm rør  Polyethylen-hjul Rustfri bolte Vægt: 3 Kg	802180
	Galvansieret forstærkningsbånd med bolte til Ø60mm rør  Der skal monteres fixseringsbånd for min. hver 180 m transportrør.	800160

## Udløb

Varegruppe 405

Model.	Beskrivelse.	Vare nr.
	Electropneumatic udløb "Extravalve" Med rustfrit stål skod Galvaniseret rør Udløb: Ø75mm Vægt: 1,5 Kg	608011
	Udløb med skod for Ø60mm rør Udløb: Ø75mm Vægt: 250g	608020
	Udløb med rustfrie bolte for Ø75mm rør Udløb med rustfrie bolte for Ø63mm rør Udløb med rustfrie bolte for Ø60mm rør Udløb med rustfrie bolte for Ø50mm rør Udløb med rustfrie bolte for Ø45mm rør Udløb med rustfrie bolte for Ø38mm rør Udløb: Ø60mm Vægt: 225g	811110 811108 811107 811105 811104 811103
	Plastik bånd til fiksering udløb 300mm x 4,8mm Pakkestr.: 100 Stk.	701100
	Spændebånd til fiksering, galvaniseret Pakkestr.: 25 Stk	801103
	Clamps til fiksering 2-delte for Ø60mm rør	801060



## Sensorer

Varegruppe 405

Model.	Beskrivelse.	Vare nr.
	Electromagnetisk niveau indikator	810112
	Electromagnetisk niveau indikator – justerbar forsinkelse: 1 sek. – 10 min justerbar føler afstand: 4 – 12mm	810110
	Electromagnetisk niveau indikator – justerbar forsinkelse: 1 sek. – 10 min justerbar føler afstand: 4 – 12mm	810111
	Monteringsbeslag PVC for niveau indikator til alle slags rør	810128
	Gennemføring PG36	810155
	Fikseringsbeslag galvaniseret for Ø60mm rør	810156-60
	Fikseringsbeslag galvaniseret for Ø75mm rør	810156-75
	Mekanisk niveau indikator pvc rød	380224
	Fyldkontrol for spand	380233





## Foderkasser

Varegruppe 405

Model.	Beskrivelse.	Vare nr.
	<p>Tigsa foderkasse 6 ltr. for Ø55mm rør</p> <p>Højde: 460mm Bredde: 185mm Vægt.: 1 KG Kantonindhold: 9 stk</p>	3000100
	<p>Tigsa foderkasse 10 ltr. for Ø55mm rør</p> <p>Højde: 585mm Bredde: 185mm Vægt.: 1,8 KG Kantonindhold: 9 stk</p>	3000101
	<p>Tigsa foderkasse 15 ltr. for Ø55mm rør</p> <p>Højde: 740mm Bredde: 185mm Vægt.: 2,2 KG Kantonindhold: 9 stk</p>	3000102

## Foderkasser





Varegruppe 405

Model.	Beskrivelse.	Vare nr.
	<p>Tigsa foderkasse 6 ltr. med indvendig niveau indikator for Ø55mm rør</p>	3000103
	<p>Tigsa foderkasse 10 ltr. med indvendig niveau indikator for Ø55mm rør</p>	3000104
	<p>Adapter for Ø60mm rør incl. skod og plast bånd for fiksering</p> <p>Øvrige adaptere: for 38mm, 45, 48 og 50mm rør incl. skod (PVC) og plastbånd for fiksering</p>	AP20
	<p>Special fikseringsbolte 2 stk. PVC røde</p>	1111499
	<p>Kabelbøjle rustfrit stål</p>	2000105





## Foderkasser med fiksering

Varegruppe 405

Model.	Beskrivelse.	Vare nr.
	<p>TIGSA EVOLUTION foderkasse 6 l</p> <p>bestående af:                      Adapter for Ø 60mm rør                      med skod og spec. fikseringsbolte                      Vægt: 1,5 KG                      Kartonindhold: 9 stk.</p>	3560009
	<p>TIGSA EVOLUTION foderkasse 6 l</p> <p>bestående af:                      Adapter for Ø 75mm rør                      med skod og spec. fikseringsbolte                      Vægt: 1,5 KG                      Kartonindhold: 9 stk.</p>	3560013
	<p>TIGSA EVOLUTION foderkasse 9 l</p> <p>bestående af:                      Adapter for Ø 60mm rør                      med skod og spec. fikseringsbolte                      Vægt: 1,9 KG                      Kartonindhold: 9 stk.</p>	3560010
	<p>Nedløbsrør for Tigsas foderkasser                      70 x 1,5mm galvaniseret                      Længde: 6 meter.</p>	818173
	<p>Nedløbsrør for Tigsas foderkasser,                      PVC, transparent                      70,5 x 2,0mm                      Længde: 3 meter.</p>	814071



## Foderkasser med fiksering

Varegruppe 405

Model.	Beskrivelse.	Vare nr.
	Mial foderkasse 6 ltr. PVC for Ø60mm rør	700205
	Mial foderkasse 8 ltr. PVC for Ø60mm rør	700905

## Fikseringskæde, m.m.

Varegruppe 405

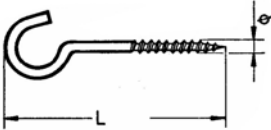
Model.	Beskrivelse.	Vare nr.
	S-kroge galvaniseret 3(d) x 30(L)mm  Pakkeindhold: 25 stk	801112
	Fikseringskæde, galvaniseret  Pakkeindhold: 30 m	801111
	Krog for vægfiksering, galvaniseret L: 120mm,  Pakkeindhold: 100 stk	801116

## Flex rustfri centrifugalpumper

Varegruppe 415

Model.

Beskrivelse.



Flex rustfri centrifugalpumper til  
Vådfodringsanlæg, transport af Valle mm.  
Alle væskeberørte dele i AISI 316l rustfrit stål  
Motor 3 x 230/400V, 50Hz, 2900 omdr. IP55.  
Kapaciteter op til 50m<sup>3</sup>/h. Maximal driftstemperatur 90°C.

Pumper med hårdmetalspakninger til vådfodringsanlæg samt øvrige væsker med slibende indhold.						Vare nr.
Kapacitet m <sup>3</sup> /h	Tryk m.w.c.	Indgang BSP	Afgang BSP	Motorstr. kW	Motoromd. RPM	
10	10	1"	3/4"	0,37	2900	EFI-2003H
18	8	1 1/2"	1"	0,75	2900	EFI-2107H
20	17	1 1/2"	1 1/2"	1,5	2900	EFI-2215H
20	22	1 1/2"	1 1/2"	2,2	2900	EFI-2222H
30	15	1 1/2"	1 1/2"	2,2	2900	EFI-2222AH
35	10	2"	2"	3,0	2900	EFI-2330H
40	15	2"	2"	4,0	2900	EFI-2340BH
20	40	2"	2"	4,0	2900	EFI-2340H
50	23	2"	2"	5,5	2900	EFI-2355H
Pumper med standardpakninger til transport af valle og andre ikke slibende væsker.						Vare nr.
Kapacitet m <sup>3</sup> /h	Tryk m.w.c.	Indgang BSP	Afgang BSP	Motorstr. kW	Motoromd. RPM	
10	10	1"	3/4"	0,37	2900	EFI-2003
18	8	1 1/2"	1"	0,75	2900	EFI-2107
20	17	1 1/2"	1 1/2"	1,5	2900	EFI-2215
20	22	1 1/2"	1 1/2"	2,2	2900	EFI-2222
30	15	1 1/2"	1 1/2"	2,2	2900	EFI-2222A
35	10	2"	2"	3,0	2900	EFI-2330
40	15	2"	2"	4,0	2900	EFI-2340B
20	40	2"	2"	4,0	2900	EFI-2340
50	23	2"	2"	5,5	2900	EFI-2355

## FLEX pumpe Tegning

Varegruppe 425

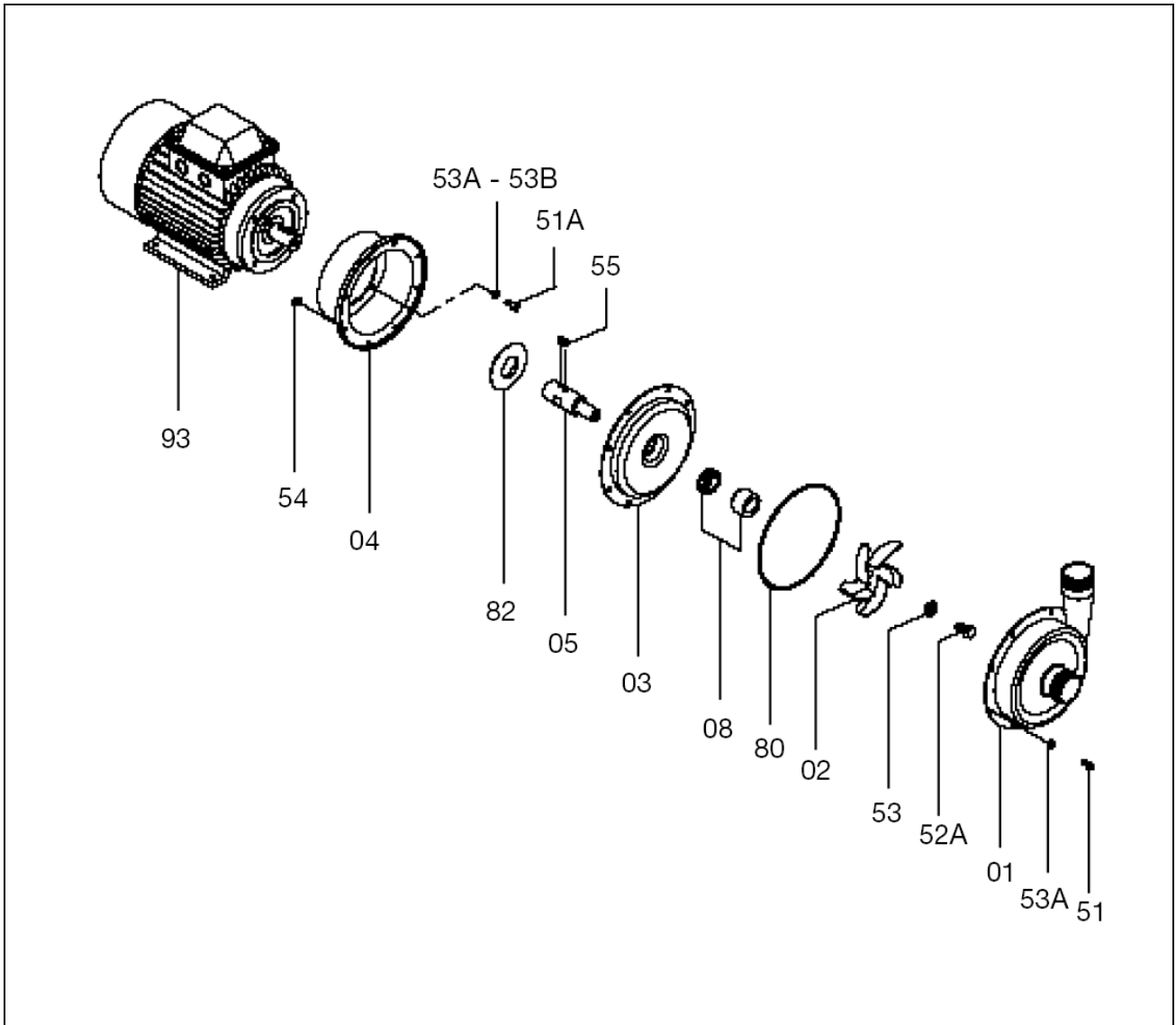

## Dele til FLEX pumpe

Varegruppe 425

<i>Model.</i>	<i>Beskrivelse.</i>	<i>Vare nr.</i>
pos. 1	Pumpehus ES-2003	201876
pos. 3	Pumpedæksel ES-2222	303246
pos. 3	Pumpedæksel ES-2003	303332
pos. 3	Pumpedæksel ES-2107	303373
pos. 3	Pumpedæksel ES-2340/2355	303374
pos. 53	Skive rustfri DIN-6796 D.10	3YAD10I
pos. 55	Penolskrue rustfri DIN-915 M6x10	3YEB6X10
pos. 52A	Skrue rustfri DIN-933 M10x20 sæt	3YT10X20I
pos. 82	Pakning D.35	400691
pos. 82	Pakning	407230
pos. 82	Pakning D30/32	407231
pos. 82	Pakning D.40	407232
pos. 1	Pumpehus ES-2107	4E+11
pos. 1	Pumpehus ES-2222	4E+12
pos. 1	Pumpehus EFI - 2340/2355	4E+13
pos. 2	Løbehjul EFI-2355A med nøgle	4EFI023AA
pos. 2	Løbehjul t/EFI-2340	4EFI023AB
pos. 2	Løbehjul t/EFI-2355	4EFI023AC
pos. 4	Pumpekonsol EFI-2003	4EFI040
pos. 4	Pumpekonsol	4EFI041
pos. 4	Pumpekonsol	4EFI042
pos. 4	Pumpekonsol	4EFI043
pos. 5	Aksel	4EFI050
pos. 5	Aksel	4EFI051
pos. 5	Aksel EFI-2222	4EFI052
pos. 5	Aksel for EFI-2340/2355	4EFI053E
pos. 2	Løbehjul ES-2003	4ES020

## Dele til FLEX pumpe

Varegruppe 425

<i>Model.</i>	<i>Beskrivelse.</i>	<i>Vare nr.</i>
pos. 2	Løbehjul ES-2107	4ES021
pos. 2	Løbehjul ES-2222	4ES022
pos. 2	Løbehjul ES-2222A	4ES022A
pos. 8	Pakningssæt R3 GV7.20	4GR3014.20
pos. 8	Akseltætning STANDARD t/EFI2340/2355	4GR3014.25
pos. 8	Akseltætning HÅRDMETAL t/EFI2340/2355	4GR3335.25
pos. 80	O-ring 115x3	4JT115X3S
pos. 80	O-ring 145x3 Silikone	4JT145X3S
pos. 80	O-ring t/EFI2340/2355	4JT195X3S
pos. 80	O-ring 98x3 Silikone	4JT98X3S
pos. 53B	Skive rustfri DIN-127 D.6	AG0006
pos. 53A	Skive rustfri DIN-127 D.8	AG0008
pos. 53A	Skive rustfri DIN-127 D.10	AG0010
pos. 55	Penolskrue DIN-916 M6x10	E10610
pos. 55	Penolskrue rustfri DIN-916 M8x8	E10808
pos.	Kontakt	KL10000-2
pos. 51A	Bolt rustfri	TA0612
pos. 51	Bolt rustfri Din-912 M6x16	TA0616
pos. 51A	Bolt rustfri DIN-912 M8x16	TA0816
pos. 51	Bolt rustfri DIN-912 M8x20	TA0820
pos. 51	Bolt rustfri	TA1020
pos. 54	Møtrik rustfri	TU0006
pos. 54	Møtrik rustfri DIN-934 M8	TU0008
pos. 54	Møtrik rustfri DIN-934 M10	TU0010
pos.	Nippemuffe 3" x 2" rustfri 316 Ref. 241	75736586

## EFI Pumpe SE26E2055H

Varegruppe 425

<i>Model.</i>	<i>Beskrivelse.</i>	<i>Vare nr.</i>
pos. 01	Pumpehus 3" indløb/ 2" afgang, rørgvind	1C150-001002606G1
pos. 02	Løbehjul Ø145 mm.	4P0226
pos. 03	Bagplade for pumpehus	302274
pos. 04	Pumpekonsol	
pos. 05	Pumpeaksel	4SE0526E
pos. 07	Ben	
pos. 07A	Justerbar ben	
pos. 08	Akseltætning hårdmetal	
pos. 08A	Akseltætning hårdmetal	4GD2447.25
pos. 14	Beskyttelsesskjold	
pos. 15	Klemring til pumpehus	4F152
pos. 39	Motor bøsning	
pos. 45	Møtrik for pumpeaksel	4P452A
pos. 50	Skrue	
pos. 51	Unbracko skrue din-912 M8x16	TA0816
pos. 52	Bolt	
pos. 52A	Bolt din-933 M10x45	TE1045
pos. 53	Skive	
pos. 53A	Rustfri skive	AP0010
pos. 53B	Rustfri fjeder skive	AG0008
pos. 55	Pindbolt din-916 M8x8	E10808
pos. 80A	O-ring 164.69x3.53 EPDM	4JT164x3.5E
pos. 80D	O-ring 28.17x3.53 EPDM	4JT28x3.5E
pos. 82	Tætningsring	407232
Pos. 93	Motor	

### 4-20-1

## EFI Pumpe SE26E2055H Tegning

Varegruppe 425

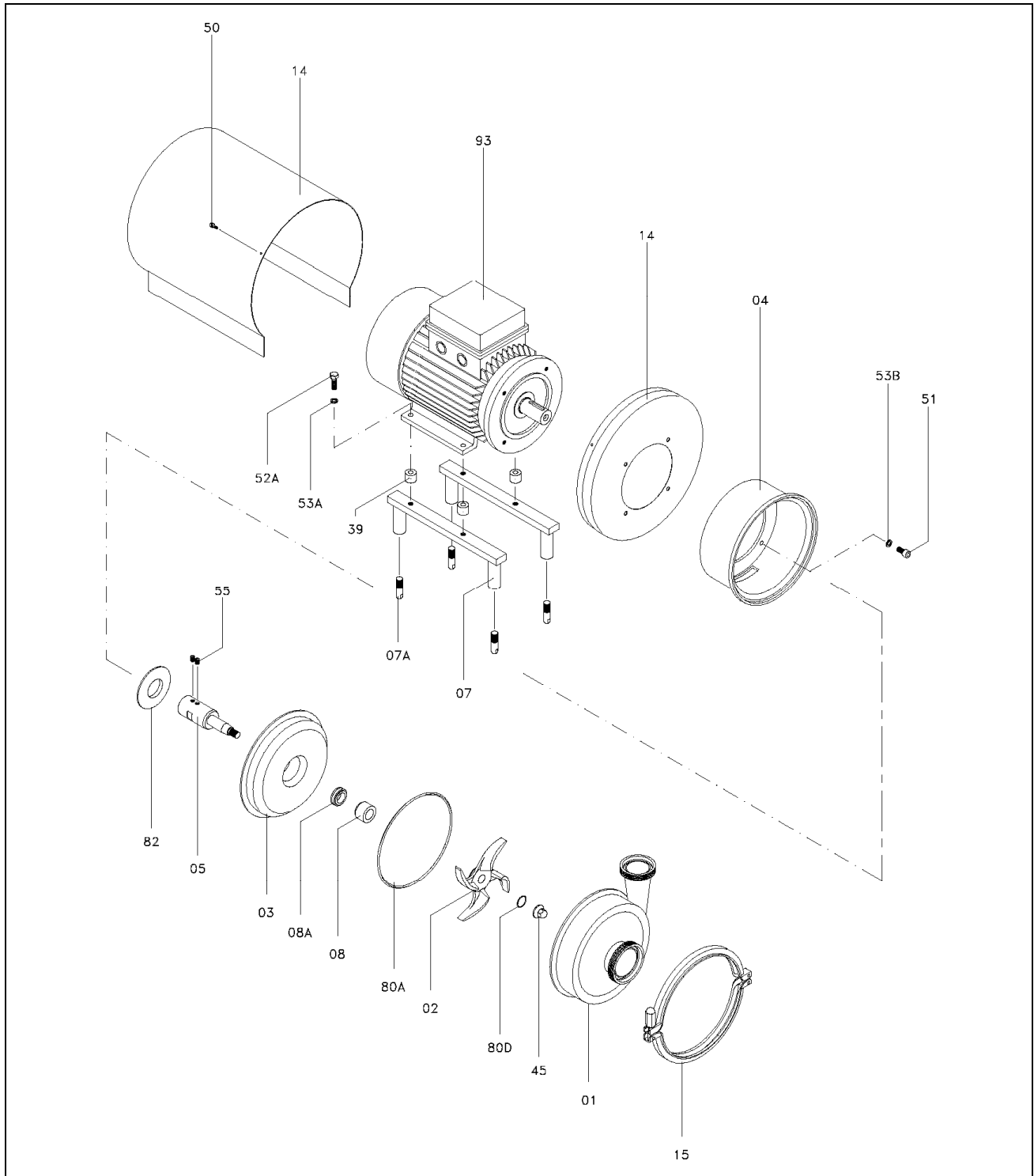

**4-20-2**



## NETZSCH Pumper

Varegruppe 417



Billeder.	Beskrivelse.	Vare nr.
	Netzsch Excentersnekkepumpe u/motor Model NX417	NX417
	Netzsch Excentersnekkepumpe Model NM045L Pumpeydelse v/400 omdr. ca.16m <sup>3</sup> /h-P max 6 bar	NM045SY01L06B
	Netzsch Excentersnekkepumpe Model NM045D Pumpeydelse v/400 omdr. ca.12m <sup>3</sup> /h-P max 9 bar	NM045SY02D09B



	Netzsch Excentersnekkepumpe Model NM045LB 3 kw gearmotor 400 omdr. ca.16m <sup>3</sup> /h-P max 6 bar	NM045BY01L06B-M
--	--	-----------------

## Gearmotorer med Kobling for Excentersnekkepumper

Varegruppe 417

Billeder.	Beskrivelse.	Vare nr.
	Flex Gearmotor Model Vem 5,5 hk Gearmotor m/vca kobling Ø25mm Gearudveksling til 400 Omdr.	NE55400
	Flex Gearmotor Model Vem 5,5 hk Gearmotor m/vca kobling Ø25mm Gearudveksling til 354 Omdr.	NE55354







## NETZSCH Reservedele for M038BY01L06B

Varegruppe 427

Billeder.	Beskrivelse.	Vare nr.
	Stator Mål 425x85mm	NM038 3160797
	Rotor	NM038 3162278
	Koblingsstang	NM038 3162481
	Kardanledsbolt	NM038 3163071
	Kappe T/Koblingsstang	NM038 3163165
	Klemring	NM038 3163173
	Springring	NM038 3163166
	Manchet	NM038 3163172
	O-Ring	NM038 3163164
	Akseltætning	NM038 3164004

## NETZSCH Stator for NM0045

Varegruppe 427

<i>Billeder.</i>	<i>Beskrivelse.</i>	<i>Vare nr.</i>
	Stator m/lang geometri til NM045-01L Mål 493x101mm	3160803
	Rotor m/lang geometri til NM045-01L	3162279
	Stator m/kort geometri til NM045-02S Mål 493x101mm	3160624
	Rotor m/kort geometri til NM045-02S	3162380
	Stator m/mellemlang geometri til NM045-01M Mål 493x101mm	3160810M
	Rotor m/mellemlang geometri til NM045-01M	3162417

**NETZSCH NM045SY01L06B og NM045SY02S06B  
og NM045SY01M06B**

Varegruppe 427

<i>Pos.</i>	<i>Beskrivelse.</i>	<i>Vare nr.</i>
Pos. 0005	Lejehus	892863
Pos. 0020	Kugleleje	691454
Pos. 0027	Passkive	691455
Pos. 0028	Passkive	691456
Pos. 0030	Akseltætning	691457
Pos. 0035	Sikringsring	512003
Pos. 0041	Akseltætning	944123
Pos. 0050	Nilos-ring	691459
Pos. 0055	Støtteskive	512239
Pos. 0065	Støtteskive	512152
Pos. 0110	Kugleleje	691460
Pos. 0135	Sikringsring	512096
Pos. 0310	Nilos-ring	514063
Pos. 0315	Sikringsring	512052
Pos. 1005	Drivaksel	194527
Pos. 1010	Feder	470313
Pos. 1998	Koblingsstang	955157
Pos. 1999	Rotor type <b>L</b>	5076160
Pos. 1999	Rotor type <b>S</b>	3162380
Pos. 1999	Rotor type <b>M</b>	3162417
Pos. 2005	Endestykke	892870
Pos. 2010	Hus	892864
Pos. 2015	Reduktionsskrue	689845
Pos. 2016	Reduktionsskrue	508342
Pos. 2020	Tapskrue	500186
Pos. 2025	Fjederskive	502199
Pos. 2030	Møtrik	501061
Pos. 2035	Støttefod	892985
Pos. 3005	Stator iFD type <b>L</b>	5078049
Pos. 3005	Stator iFD type <b>S</b>	3160624
Pos. 3005	Stator iFD type <b>M</b>	3160803
Pos. 3001	Varmekappe iFD	5077337

**4-24-1**

**NETZSCH NM045SY01L06B og NM045SY02S06B  
og NM045SY01M06B**

Varegruppe 427

<i>Pos.</i>	<i>Beskrivelse.</i>	<i>Vare nr.</i>
Pos. 3002	Stator iFD	5077349
Pos. 3010	Stagbolt	955694
Pos. 3015	Fjederskive	502200
Pos. 3020	Møtrik	501062
Pos. 3070	Skive	502151
Pos. 5055	Koblingsmedbringer	955167
Pos. 5065	Låsering	892988
Pos. 5070	Cylinderstift	678959
Pos. 5075	Cylinder bolt	892991
Pos. 5110	Bøsning	955137
Pos. 5115	Bøsning	955342
Pos. 5425	Klemring	892895
Pos. 5990	Smøremiddel	691232
Pos. 7005	Sæderingsbøsning	5020246
Pos. 7007	Reduktionsskrue	508520
Pos. 7008	Tætningsring	422215
Pos. 7010	Mekanisk akseltætning	678318
Pos. 8010	Tætningsring	422526
Pos. 8012	Tætningsring	422527
Pos. 8015	O-ring	516573
Pos. 8060	O-ring	516333
Pos. 8065	O-ring	516955
Pos. 8253	SM®-tætningsmanchet	892894

**4-24-2**

## NETZSCH NM045SY01L06B og NM045SY02S06B og NM045SY01M06B

Varegruppe 427

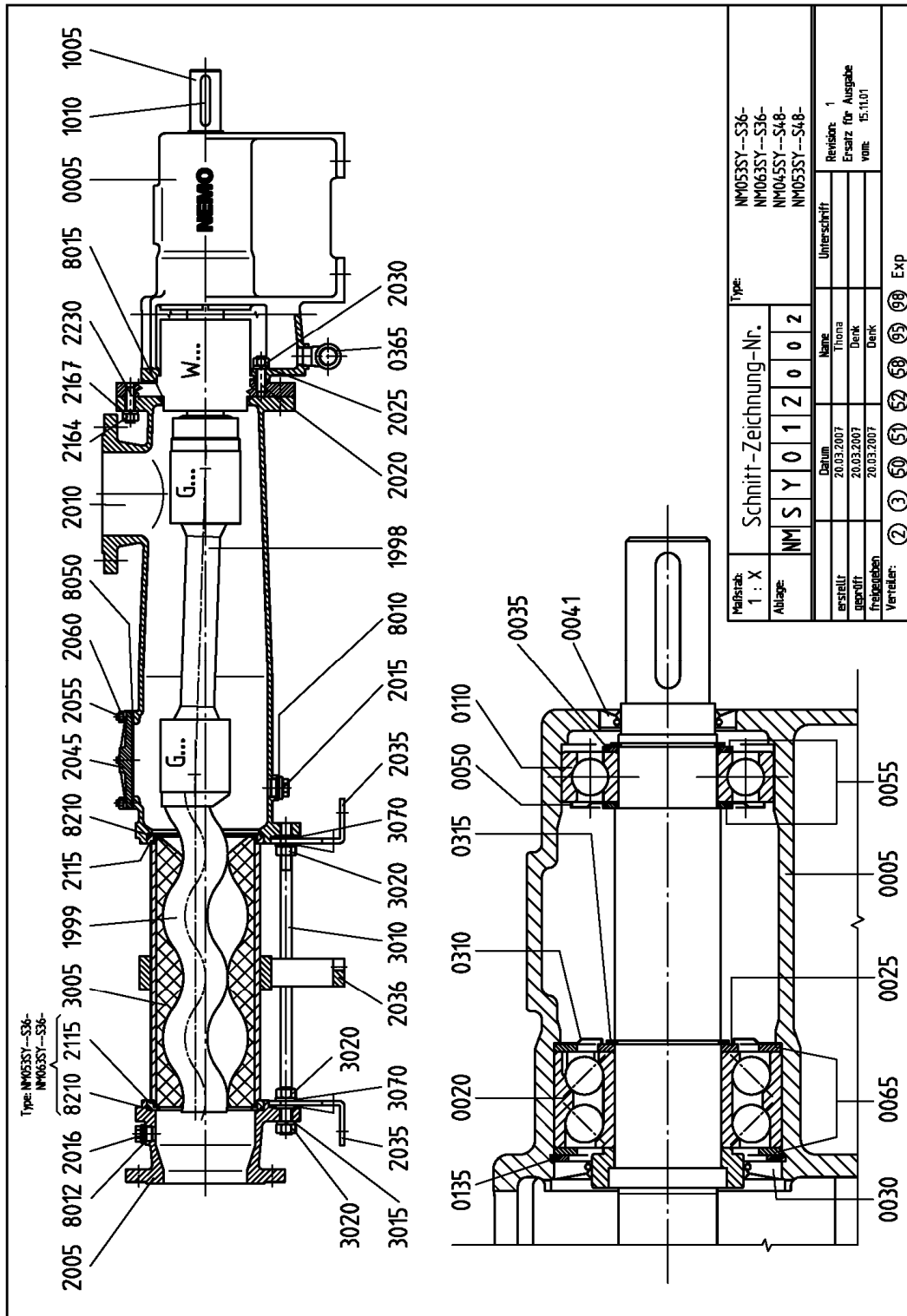

4-24-3

## NETZSCH NM045BY01L06B og NM045BY02S06B og NM045BY01M06B

Varegruppe 427

Pos.	Beskrivelse.	Vare nr.
Pos. 0085	Motorstol	5066505
Pos. 0120	Fjederskive	502199
Pos. 0125	Sekskantskrue	500269
Pos. 0140	Møtrik	501061
Pos. 1030	Cylinderstift	5067632
Pos. 1035	Slyngring	5066418
Pos. 1050	Stikaksel	5066796
Pos. 1998	Koblingsstang	955157
Pos. 1999	Rotor type <b>L</b>	5076160
Pos. 1999	Rotor type <b>S</b>	3162380
Pos. 1999	Rotor type <b>M</b>	3162417
Pos. 2005	Endestykke	892870
Pos. 2010	Hus	892864
Pos. 2015	Prop	689845
Pos. 2016	Prop	508342
Pos. 2020	Tapskrue	500186
Pos. 2025	Fjederskive	502199
Pos. 2030	Møtrik	501061
Pos. 2035	Støttefod	892985
Pos. 3005	Stator iFD type <b>L</b>	5078049
Pos. 3005	Stator iFD type <b>S</b>	3160624
Pos. 3005	Stator iFD type <b>M</b>	3160803
Pos. 3001	Statorhus	5077337
Pos. 3002	Stator clamp iFD	5077349
Pos. 3010	Stagbolt	955694
Pos. 3015	Fjederskive	502200
Pos. 3020	Møtrik	501062
Pos. 3070	Skive	502151
Pos. 5065	Låsering	892988
Pos. 5075	Cylinder bolt	892991
Pos. 5115	Bøsning	955342

### 4-24-4

**NETZSCH NM045BY01L06B og  
NM045BY02S06B og NM045BY01M06B**

Varegruppe 427

<i>Pos.</i>	<i>Beskrivelse.</i>	<i>Vare nr.</i>
Pos. 5425	Klemring	892895
Pos. 5990	Mineralolie	5072627
Pos. 7005	Sæderingsbøsning	5066860
Pos. 7010	Mekanisk akseltætning	677329
Pos. 8010	Tætningsring	422526
Pos. 8012	Tætningsring	422527
Pos. 8015	O-ring	516573
Pos. 8060	O-ring	678781
Pos. 8235	SM®-tætningsmanchet	955122
Pos. 9500	Drivstation	5113049

**4-24-5**



## NETZSCH NM045BY01L06B og NM045BY02S06B og NM045BY01M06B

Varegruppe 427

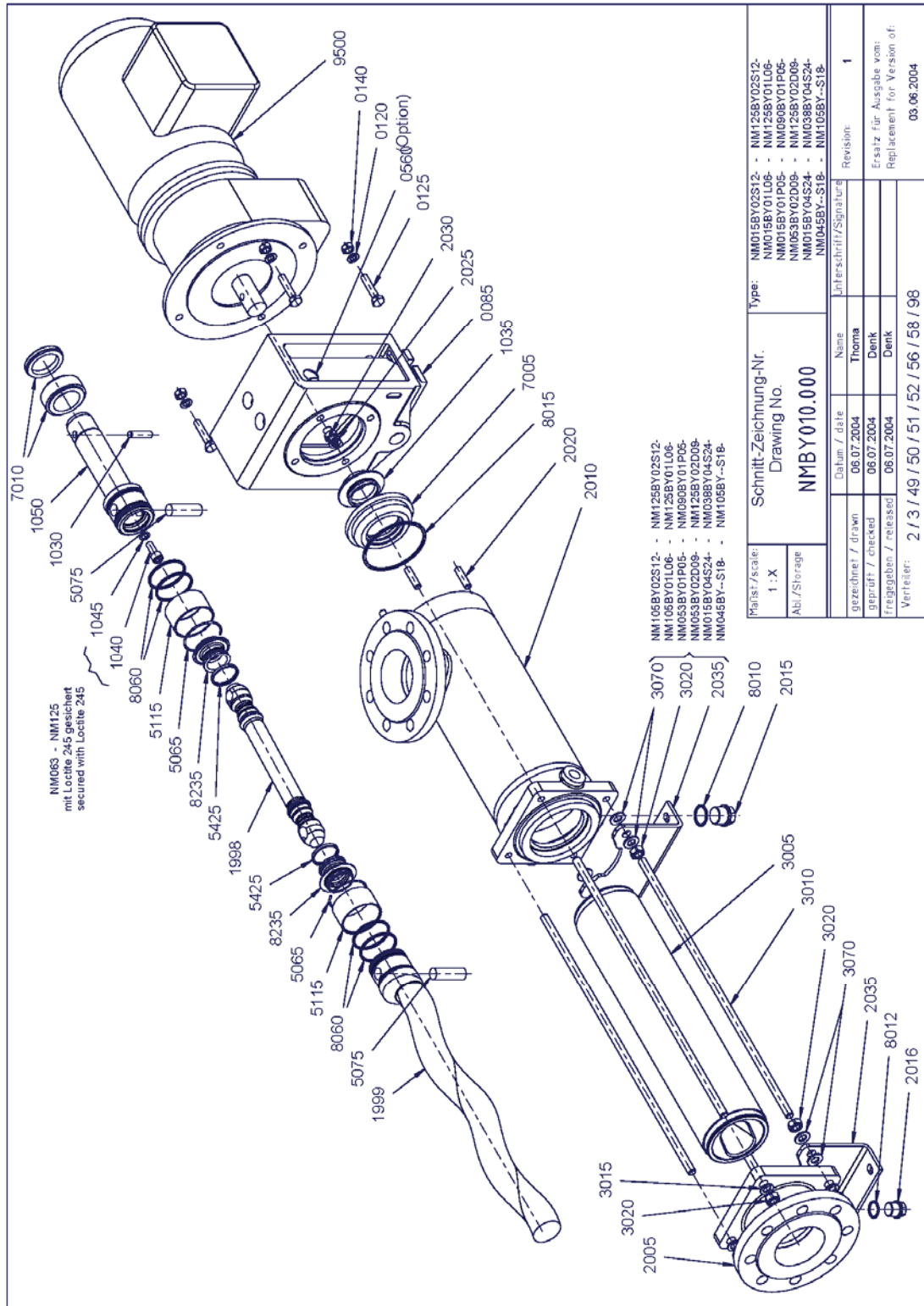

4-24-6

## NETZSCH NX417/300

Varegruppe 427

Pos.	Beskrivelse.	Vare nr.
Pos. 0005	Lejehus	866785
Pos. 0010	Afstandsstykke	866782
Pos. 0020	Kugleleje	580579
Pos. 0025	Støtteskive	512220
Pos. 0035	Sikringsring	512052
Pos. 0055	Støtteskive	512152
Pos. 0110	Kugleleje	580482
Pos. 0135	Sikringsring	512096
Pos. 1005	Drivaksel	892980
Pos. 1010	Feder	470313
Pos. 1998	Koblingsstang	892981
Pos. 1999	Rotor	165460
Pos. 2005	Endestykke	886171
Pos. 2010	Hus	886170
Pos. 2015	Reduktionsskrue	520300
Pos. 2020	Tapskrue	508105
Pos. 2025	Fjederskive	502200
Pos. 2030	Møtrik	501062
Pos. 2195	Reduktionsskrue	520297
Pos. 3005	Stator	167168
Pos. 3010	Stagbolt	850616
Pos. 3015	Fjederskive	502200
Pos. 3020	Møtrik	501062
Pos. 5055	Adapter	864485
Pos. 5065	Låsering	512279
Pos. 5070	Cylinder bolt	506364
Pos. 5075	Cylinder bolt	868664
Pos. 5110	Bøsning	864481
Pos. 5115	Bøsning	862347
Pos. 5425	Klemring	877421
Pos. 7005	Sæderingsbøsning	866784
Pos. 7010	Mekanisk akseltætning	689435
Pos. 7055	Afstandsbøsning	878688

### 4-24-7

**NETZSCH NX417/300**

Varegruppe 427

<i>Pos.</i>	<i>Beskrivelse.</i>	<i>Vare nr.</i>
Pos. 8010	Tætningsring	422526
Pos. 8015	O-ring	516457
Pos. 8060	O-ring	517020
Pos. 8065	O-ring	516522
Pos. 8165	Pakning	422740
Pos. 8235	SM®-tætningsmanchet	877401

**4-24-8**

## NETZSCH NX417/300

Varegruppe 427

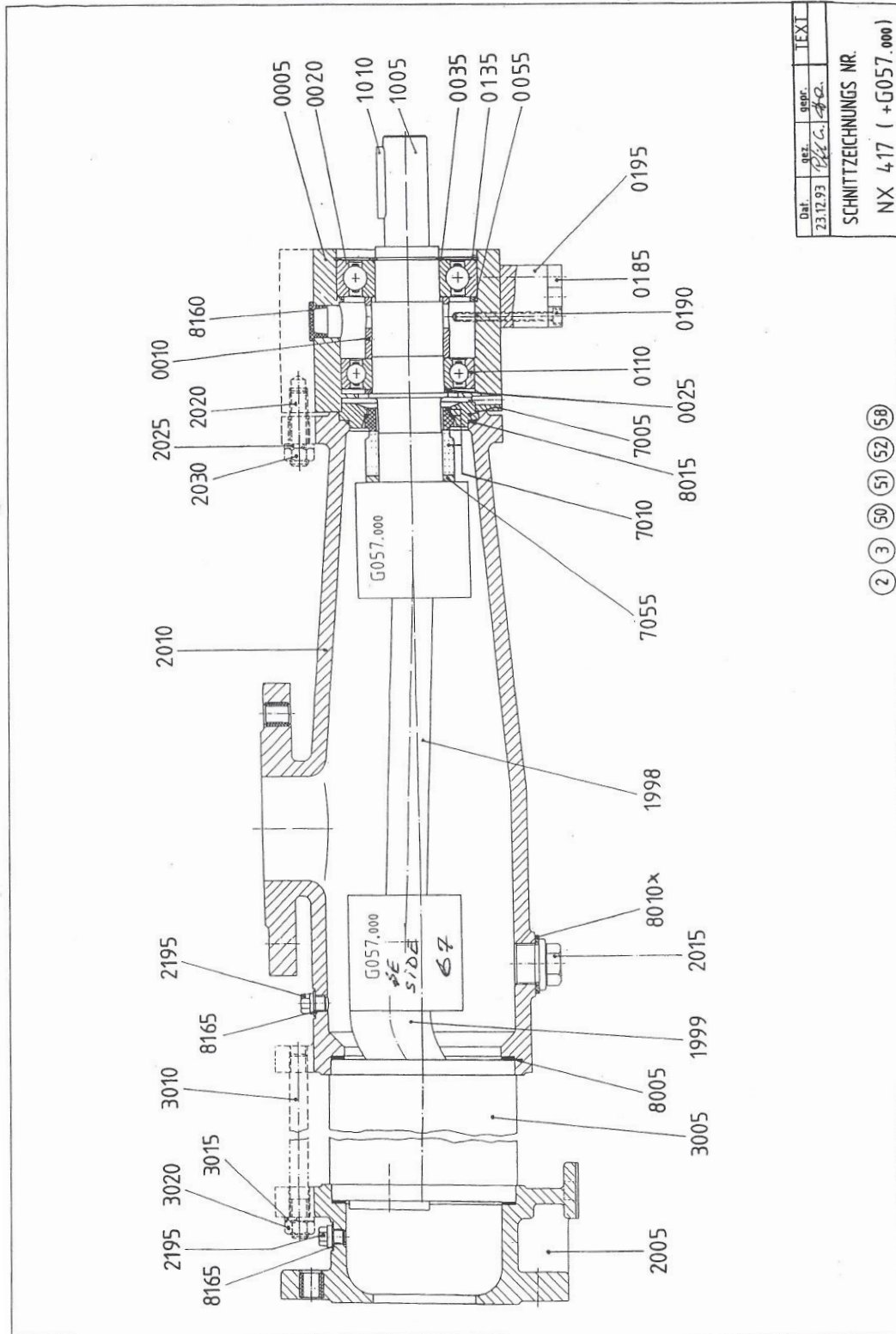

4-24-9

**SEEPEX Reservedele for 17 - 6L Pumpe**

Varegruppe 427

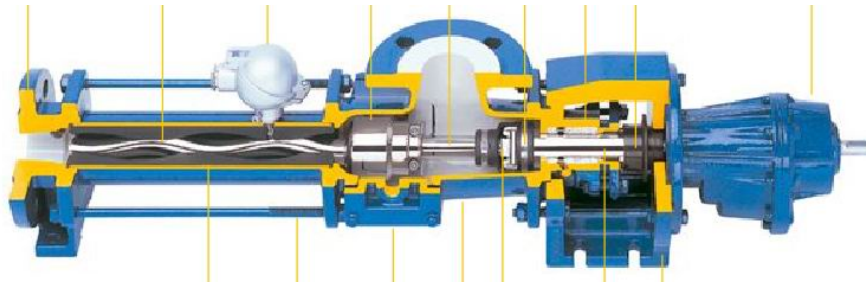
*Beskrivelse.**Vare nr.*

	<i>Beskrivelse.</i>	<i>Vare nr.</i>
	Stator Mål 530x122mm	17-6L 3165284
	Rotor	3160564
	Koblingsstang	3163022
	Kardanledsbolt	3163026
	Kardanledsbøsning	3163025
	Kappe	3163027
	Styrebøsning	3163024
	Manchet	3163030
	Spændebånd	(Stor) Stål 3163028
	Spændebånd	(Lille) Stål 3163029

## WANGEN Pumper

Varegruppe 419



Beskrivelse.

Vare nr.

	WANGEN excentriskpumpe Model BD 50	419WABD50
--	---------------------------------------	-----------

## Gearmotorer med Kobling for Excentersnekkepumper

Varegruppe 417

Billeder.

Beskrivelse.

Vare nr.

	Flex Gearmotor Model Vem 5,5 hk Gearmotor m/vca kobling Ø25mm Gearudveksling til 400 Omdr.	NE55400
	Flex Gearmotor Model Vem 5,5 hk Gearmotor m/vca kobling Ø25mm Gearudveksling til 354 Omdr.	NE55354
	Flex Gearmotor Model Vem 5,5 hk Gearmotor m/vca kobling Ø25mm Gearudveksling til 310 Omdr.	NE55310

**WANGEN Reservedele BD 50**

Varegruppe 429

<i>Pos.</i>	<i>Beskrivelse.</i>	<i>Vare nr.</i>
Pos. 1	Lejehus Fedtstof Typeskilt	11692 15121 16912
Pos. 2	Pumpehus	11726
Pos. 3	Pumpe afgang DN 65/PN 16	11756
Pos. 4	Rotor #40	11850
Pos. 5	Drivaksel	11861
Pos. 6	Lejeflange	11863
Pos. 7	Hylster for koblingsstang KG 50, 050x246, *300, #40 (BD)	11871
Pos. 8	Stavbolt M12x 615, #40 (BD)	15136
Pos. 9	Kravemøtrik 50K	11869
Pos. 10	Øsken bolt	11875
Pos. 11	O-ring DIN3770-105x4	11877
Pos. 12	Stator 50.0	10071
Pos. 13	O-ring DIN3770- 75x2,5	11878
Pos. 14	Mekanisk akseltætning HN40003 -30 -left	11346

**WANGEN Reservedele BD 50**

Varegruppe 429

<i>Pos.</i>	<i>Beskrivelse.</i>	<i>Vare nr.</i>
Pos. 15	Læbering DIN3760-A- 30x 52x 7	11879
Pos. 16	Kugleleje 6306-2RSR	11880
Pos. 17	Låsering DIN471- 30x1,5	10873
Pos. 18	Koblingsstang	11882
Pos. 19	Not DIN6885-A 8x 7x 36	13597
Pos. 20	Bolte DIN912-M 5x 14	12657
Pos. 21	Låsemøtrik DIN934-M12	10844
Pos. 22	Låseskive DIN125-A 13	10843
Pos. 23	Pindbolt	16576
Pos. 24	Konisk stift IS08734 - 4m6x28	12813
Pos. 25	Afstandsbojsninger	10776
Pos. 26	Lejeflange #40	11703
Pos. 27	O-ring D1N3770- 26x2	13015



# WANGEN BD 50 Tegning

Varegruppe 429

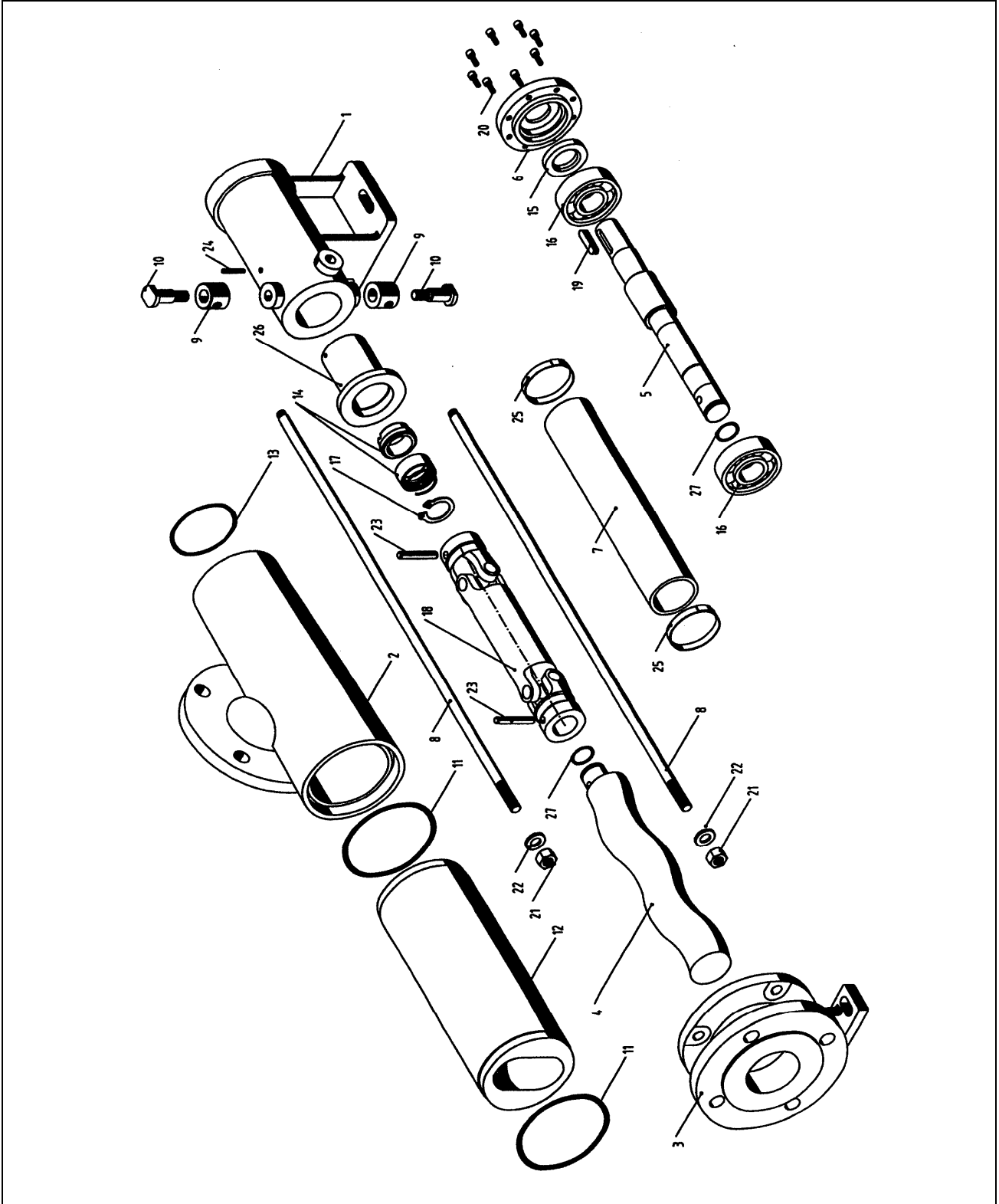

**WANGEN KL 30S 6.0**

Varegruppe 429

<i>Pos.</i>	<i>Beskrivelse.</i>	<i>Vare nr.</i>
Pos. 1012	Hus	
Pos. 1013	O-ring	
Pos. 1014	Bundprop	
Pos. 1015	Skive	
Pos. 1033	pumpeafgang	
Pos. 1034	Skrue	
Pos. 1035	Samlering	
Pos. 1036	Rotor	
Pos. 1037	Stator	
Pos. 1039	O-ring	
Pos. 1040	Afstandsring	
Pos. 1041	Stang	
Pos. 1042	Skive	
Pos. 1043	Møtrik	
Pos. 1049	Hylster for koblingsstang	
Pos. 1050	Klemmebånd	
Pos. 1052	Knækleds samling	
Pos. 1053	Bøsning	
Pos. 1054	Pind	
Pos. 1055	Pind bolt	
Pos. 1112	Fod	
Pos. 1307	Samleboldt	
Pos. 1308	Møtrik	
Pos. 1511	Lejebuk, komplet	

**WANGEN KL 30S 6.0**

Varegruppe 429

<i>Pos.</i>	<i>Beskrivelse.</i>	<i>Vare nr.</i>
Pos. 1521	Pakning	
Pos. 1522	Inspektionsdæksel	
Pos. 1523	Møtrik	
Pos. 1524	Samleboldt	
Pos. 1577	Fødesnegl	
Pos. 1585	Mellemhus	
Pos. 1586	O-ring	
Pos. 1587	Fjederring	
Pos. 1588	Bolt	
Pos. 1957	Skrue	
Pos. 1958	O-ring	
Pos. 1959	Bolt	
Pos. 1960	Kardanaksel	
Pos. 1961	Skive	
Pos. 1962	O-ring	

**4-29-2**

## WANGEN KL 30S 6.0 Tegning

Varegruppe 429

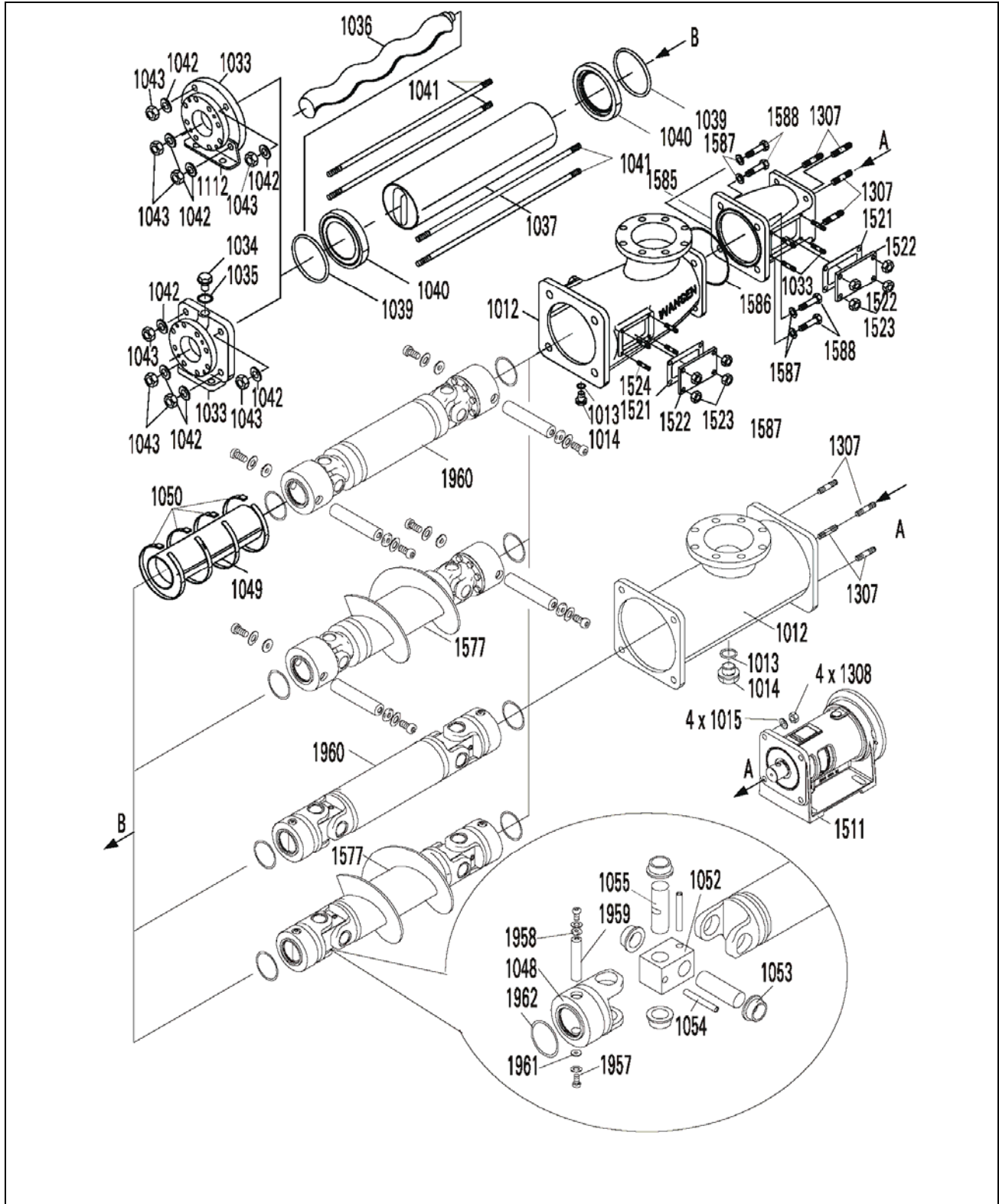

4-29-3

**WANGEN KL 30S 6.0 Mellemhus Reservedele**

Varegruppe 429

<i>Pos.</i>	<i>Beskrivelse.</i>	<i>Vare nr.</i>
Pos. 1000	Drivaksel	
Pos. 1001	Mellemhus komplet med aksel	
Pos. 1002	Tætningsring	
Pos. 1003	Leje	
Pos. 1006	Prop	
Pos. 1007	Leje	
Pos. 1008	Pinolskrue	
Pos. 1009	Låsering	
Pos. 1010	Pakdåse	
Pos. 1011	Skrue	
Pos. 1017	Låsering	
Pos. 1018	O-ring	
Pos. 1019	O-ring	
Pos. 1020	Låsering	
Pos. 1021	Stift	
Pos. 1022	Samlebolt	
Pos. 1023	Møtrik	
Pos. 1024	Hylster for koblingstang	
Pos. 1025	Hus	
Pos. 1026	Pakning	
Pos. 1027	Tætningshus	
Pos. 1028	Tætningsring	
Pos. 1029	Tætningsplade	
Pos. 1030	Rørstift	
Pos. 1031	Akseltætning	

**4-29-4**

**WANGEN KL 30S 6.0 Mellearhus Reservedele**

Varegruppe 429

<i>Pos.</i>	<i>Beskrivelse.</i>	<i>Vare nr.</i>
Pos. 1104	Flange	
Pos. 1105	Spændskive	
Pos. 1106	Hus	
Pos. 1107	Tætning	
Pos. 1108	Prop	
Pos. 1109	Spændring	
Pos. 1110	Tætningsring	
Pos. 1111	Pakningring	
Pos. 1118	Ring	
Pos. 1409	Låsering	
Pos. 1538	Typeplade	
Pos. 1539	Bolt	
Pos. 1540	Kit sæt	
Pos. 1541	Skueglas	
Pos. 1542	Oil for LWD	
Pos. 1554	Låsering	
Pos. 1580	Ring	
Pos. 2022	Inspektionsluger	
Pos. 2031	Plade	
Pos. 2096	Tætning	



## PVC dele

### Union, Vinkel, Bøjning

Varegruppe 431





Billeder.	Beskrivelse.	Vare nr.
	PVC union 20mm limemuffer 10 bar.	110071
	PVC union 25mm limemuffer 10 bar.	110072
	PVC union 32mm limemuffer 10 bar.	110073
	PVC union 40mm limemuffer 10 bar.	110074
	PVC union 50mm limemuffer 10 bar.	110075
	PVC union 63mm limemuffer 10 bar.	110076
	PVC union 20mm limemuffe x 1/2" indv. gevind 10 bar	110081
	PVC union 25mm limemuffe x 3/4" indv. gevind 10 bar	110082
	PVC union 32mm limemuffe x 1" indv. gevind 10 bar	110083
	PVC union 40mm limemuffe x 1 1/4" indv. gevind 10 bar	110084
	PVC union 63mm limemuffe x 2" indv. gevind 10 bar	110086
	PVC union 20mm limemuffe x 1/2" udv. gevind 10 bar	110091
	PVC union 25mm limemuffe x 3/4" udv. gevind 10 bar	110092
	PVC union 32mm limemuffe x 1" udv. gevind 10 bar	110093
	PVC union 40mm limemuffe x 1 1/4" udv. gevind 10 bar	110094
	PVC union 63mm limemuffe x 2" udv. gevind 10 bar	110096
	PVC vinkel 90 gr. 20mm limemuffer 16 bar	110106
	PVC vinkel 90 gr. 25mm limemuffer 16 bar	110107
	PVC vinkel 90 gr. 32mm limemuffer 16 bar	110108
	PVC vinkel 90 gr. 40mm limemuffer 16 bar	110109
	PVC vinkel 90 gr. 63mm limemuffer 16 bar	110111



**PVC dele**

**Vinkel, Bøjning**

Varegruppe 431

Billeder.	Beskrivelse.	Vare nr.
	PVC vinkel 90 gr. 63mm limemuf x 2" udv. gev. 10 bar	100120
	PVC vinkel 90 gr. 20mm limemuf x 1/2" indv. gev. m/ forstærkningsring 16 bar	110167
	PVC vinkel 90 gr. 25mm limemuf x 3/4" indv. gev. m/ forstærkningsring 16 bar	110168
	PVC vinkel 90 gr. 32mm limemuf x 1" indv. gev. m/ forstærkningsring 16 bar	110169
	PVC vinkel 90 gr. 40mm limemuf x 1 1/4" indv. gev. m/ forstærkningsring 16 bar	110170
	PVC vinkel 90 gr. 63mm limemuf x 2" indv. gev. m/ forstærkningsring 16 bar	110172
	PVC vinkel 45 gr. 20mm limemuffer 16 bar	110120
	PVC vinkel 45 gr. 25mm limemuffer 16 bar	110121
	PVC vinkel 45 gr. 32mm limemuffer 16 bar	110122
	PVC vinkel 45 gr. 40mm limemuffer 16 bar	110123
	PVC vinkel 45 gr. 63mm limemuffer 16 bar	110125
	PVC vinkel 45 gr. 63mm limemuf x 2" ind. gev. m/ forstærkningsring 10 bar	100130
	PVC bøjning 90 gr. 25mm limemuffer 16 bar	110178
	PVC bøjning 90 gr. 63mm limemuffer 16 bar	110204

**PVC dele**

**Bøjning, Y-stykke, T-styk**

Varegruppe 431

Billeder.	Beskrivelse.	Vare nr.
	PVC bøjning 45 gr. 63mm limemuffer 16 bar	110229
	PVC Y-stykke 63mm limemuffer	110269
	PVC T-styk. 90 gr. 20mm limemuffer 16 bar	110252
	PVC T-styk. 90 gr. 25mm limemuffer 16 bar	110253
	PVC T-styk. 90 gr. 32mm limemuffer 16 bar	110254
	PVC T-styk. 90 gr. 40mm limemuffer 16 bar	110255
	PVC T-styk. 90 gr. 63mm limemuffer 16 bar	110257
	PVC T-styk. 90 gr. 25 x 20 x 25mm limemuffer 16 bar	110288
	PVC T-styk. 90 gr. 32 x 20 x 32mm limemuffer 16 bar	110291
	PVC T-styk. 90 gr. 32 x 25 x 32mm limemuffer 16 bar	110292
	PVC T-styk. 90 gr. 40 x 20 x 40mm limemuffer 16 bar	110293
	PVC T-styk. 90 gr. 40 x 25 x 40mm limemuffer 16 bar	110294
	PVC T-styk. 90 gr. 40 x 32 x 40mm limemuffer 16 bar	110295

## PVC dele

### T-styk, Kryds

Varegruppe 431

<i>Billeder.</i>	<i>Beskrivelse.</i>	<i>Vare nr.</i>
	PVC T-styk. 90 gr. 20mm limemuf x 1/2" indv.gevind x 20mm limemuf 16 bar	110360
	PVC T-styk. 90 gr. 25mm limemuf x 3/4" indv.gevind x 25mm limemuf 16 bar	110361
	PVC T-styk. 90 gr. 32mm limemuf x 1" indv.gevind x 32mm limemuf 16 bar	110362
	PVC T-styk. 90 gr. 25mm limemuf x 1/2" indv. gev. x 25mm limemuf 10 bar	100135
	PVC T-styk. 90 gr. 32mm limemuf x 1/2" indv. gev. x 32mm limemuf 10 bar	100136
	PVC T-styk. 90 gr. 32mm limemuf x 3/4" indv. gev. x 32mm limemuf 10 bar	100137
	PVC T-styk. 90 gr. 40mm limemuf x 1" indv. gev. x 40mm limemuf 10 bar	100140
	PVC T-styk. 90 gr. 63mm limemuf x 1 1/2" udv.gevind x 63mm limemuf 16 bar	110354
	PVC kryds 20mm limemuffer 16 bar	110375
	PVC kryds 25mm limemuffer 16 bar	110376
	PVC kryds 32mm limemuffer 16 bar	110377

## PVC dele

### Overgangsniappel, Overgangsstuds, Slutmuffe, Muffe

Varegruppe 431

Billeder.	Beskrivelse.	Vare nr.
	PVC overgangsniappel 63mm limemuffe x 1 1/4" udv. gevind 16 bar	110413
	PVC overgangsniappel 63mm limemuffe x 1 1/2" udv. gevind 16 bar	110414
	PVC overgangsniappel 63mm limemuffe x 2" udv. gevind 16 bar	110415
	PVC overgangsniappel 20mm limemuffe x 1/2" udv. gevind 16 bar	110449
	PVC overgangsniappel 32/25mm limemuffe/nippel x 1" udv. gevind 16 bar	110452
	PVC overgangsniappel 50/40mm limemuffe/nippel x 1 1/4" udv. gevind 16 bar	110458
	PVC overgangsstuds 63mm limenippel x 2" udv. gevind 16 bar	110497
	PVC slutmuffe 20mm x L16mm limemuffe 16 bar	110586
	PVC slutmuffe 25mm x L19mm limemuffe 16 bar	110587
	PVC slutmuffe 32mm x L22mm limemuffe 16 bar	110588
	PVC slutmuffe 40mm x L26mm limemuffe 16 bar	110589
	PVC slutmuffe 63mm x L38mm limemuffe 16 bar	110591
	PVC muffe 20mm limemuffer 16 bar	110646
	PVC muffe 25mm limemuffer 16 bar	110647
	PVC muffe 32mm limemuffer 16 bar	110648
	PVC muffe 40mm limemuffer 16 bar	110649
	PVC muffe 63mm limemuffer 16 bar	110651

## PVC dele

### Red. Muffe, Red. Ring, Trykrør

Varegruppe 431

Billeder.	Beskrivelse.	Vare nr.
	PVC red. muffe 32/25mm limenippel/muffe x 20mm limemuffe 16 bar	110705
	PVC red. muffe 40/32mm limenippel/muffe x 20mm limemuffe 16 bar	110707
	PVC red. muffe 40/32mm limenippel/muffe x 25mm limemuffe 16 bar	110708
	PVC red. muffe 50/40mm limenippel/muffe x 25mm limemuffe 16 bar	110710
	PVC red. muffe 50/40mm limenippel/muffe x 32mm limemuffe 16 bar	110711
	PVC red. muffe 75/63mm limenippel/muffe x 50mm limemuffe 16 bar	110720
	PVC red. ring 25mm limenippel x 20mm limemuffe 16 bar	110733
	PVC red. ring 32mm limenippel x 25mm limemuffe 16 bar	110736
	PVC red. ring 40mm limenippel x 32mm limemuffe 16 bar	110740
	PVC red. ring 50mm limenippel x 40mm limemuffe 16 bar	110744
	PVC red. ring 63mm limenippel x 50mm limemuffe 16 bar	110748
	PVC trykrør 20mm á 5 m 10 bar m/1 limemuffe, mørkegrå	302000
	PVC trykrør 25mm x 1,5mm á 5 m 10 bar m/1 limemuffe mørkegrå	309025
	PVC trykrør 32mm x 1,8mm á 5 m 10 bar m/1 limemuffe mørkegrå	309032
	PVC trykrør 40mm á 5 m 10 bar m/1 limemuffe mørkegrå	309040
	PVC trykrør 63mm x 3,0mm á 5 m 10 bar m/1 limemuffe mørkegrå	309163

## PVC dele

### Trykrør, Kuglehane, Kontraventil

Varegruppe 431

Billeder.	Beskrivelse.	Vare nr.
	PVC trykrør 63mm x 4,7mm á 5 m 16 bar m/1 limemuffe mørkegrå	309230
	PVC trykrør 32mm x 2,4mm á 5 m 16 bar m/1 limemuffe mørkegrå	329133
	PVC kuglehane 25mm limemuffer m/unioner 10 bar	161501
	PVC kuglehane 32mm limemuffer m/unioner 10 bar	161502
	PVC kuglehane 40mm limemuffer m/unioner 10 bar	161503
	PVC kuglehane 50mm limemuffer m/unioner 10 bar	161504
	PVC kuglehane 63mm limemuffer m/unioner 10 bar	161505
	PVC kuglehane ½" indiv. gevind m/unioner 10 bar	111286
	PVC kuglehane ¾" indiv. gevind m/unioner 10 bar	161511
	PVC kuglehane, svær model, 63mm limemuffer m/unioner, MEGA 16 bar	111911
	PVC kuglehane, svær model, 75mm limemuffer m/unioner, MEGA 16 bar	111912
	PVC 3-vejs kuglehane 63mm limemuffer m/unioner, T-boret, 10 bar	111524
	PVC kuglehane, svær model, 3" indiv. gevind m/unioner, MEGA 16 bar	111923
	PVC kontraventil 20mm limemuffer, m/rustf. fjeder 16 bar	111540
	PVC kontraventil 25mm limemuffer, m/rustf. fjeder 16 bar	111541
	PVC kontraventil 32mm limemuffer, m/rustf. fjeder 16 bar	111542
	PVC kontraventil 40mm limemuffer, m/rustf. fjeder 16 bar	111543

## PVC dele



### PVC Lim

Varegruppe 431

Billeder.

Billeder.

Billeder.

	PVC lim 125 gr. tube	146020
	PVC lim 250 gr. dåse med pensel	146021
	PVC lim 500 gr. dåse med pensel	146025
	PVC lim 1000 gr. dåse med pensel	146023
	PVC rensmiddel 125ml	146026
	PVC rensmiddel 1 ltr.	146027

## PVC dele

### Sprinkler

Varegruppe 431

Billeder.

Billeder.

Billeder.

	Sprinkler 3/8" gevind type 7110, grøn dyse 180 gr. t/overbrusning	609052
	Sprinkler 3/8" gevind type 7110, rød dyse, 360 gr. t/iblødsætning 7,0 m	610001
	Sprinkler 3/8" gevind type 7110, gul dyse, 360 gr. t/iblødsætning 9,6 m	610014
	Sprinkler 3/8" gevind type 7110, grøn dyse, 360 gr. t/iblødsætning 3,0 m	610032
	Sprinkler Kpl. med monteringsring Model: Hardi	19030799
	Blændprop 3/8" gevind t/sprinkler	610067
	Nondryp ventil 3/8" gevind t/sprinkler	620228
	Gummi monteringsring for sprinklere m/3/8" gevindfoto	621300

## Membraner

*Passende til følgende vådfodringsanlæg*

Varegruppe 434

Billeder.	Beskrivelse.	Vare nr.
	Membran passende for Funkti rund 6 huller	31601
	Membran passende for D-Mix gl. oval 6 huller	31602
	Membran passende for BD. Ny firkant 4 huller	31603
	Membran passende for BD. Gl. rund 10 huller	31604
	Membran passende for D-Mix Ny firkant 6 huller	31605
	Membran passende for BD firkantet med 4 huller (NY høj model)	31606
	Membran passende for Weda 120 x 115 pv-2 m/4 huller (stor)	3160065
	Membran passende for Weda 97 x 91 pv-1 m/4 huller (lille)	31667



**4-39-1**



## Magnetventiler

### Foderventiler

Varegruppe 435

Billeder.	Beskrivelse.	Vare nr.
	Bürkert magnetventil <u>24V 6W</u> , Passende for BD foderanlæg	040630L
	Sokkel Passende for Bürkert magnetventil	14682
	Flex magnetventil <u>24V AC</u> Til foderanlæg	1901500AC
	Flex magnetventil <u>24V DC</u> Til foderanlæg	1901500
	Kabelstik med 0,5 m ledning Passende for Bürkert & Flex magnetventil	008376M

**4-40-1**

## Magnetventiler

### Foderventiler

Varegruppe 435

Billeder.	Beskrivelse.	Vare nr.
	<p>SIRAI 3/2 vejs magnetventil 24V DC</p> <p><b>(Normalt/Spændingsløs åben)</b> <b>Anvendes til foderventiler</b></p>	L372V01A-ZB12A
	<p>Løs Spole t/SIRAI 24V DC magnetventil</p> <p>Til model L372V01A-ZB12A</p>	ZB12A-24V
	<p>SIRAI 3/2 vejs magnetventil 24V DC</p> <p><b>(Normalt/Spændingsløs lukket)</b> <b>Anvendes til Sektionsventiler</b></p>	L372V01C-ZB12A
	<p>Løs Spole t/SIRAI 24V DC magnetventil</p> <p>Til model L372V01C-ZB12A</p>	ZB12A-24V
	<p>Kabelstik med 0,5 m ledning</p> <p>Passende for SIRAI magnetventil</p>	100022M

**4-40-2**

## Magnetventiler

### Vandventiler

Varegruppe 435

Billeder.	Beskrivelse.	Vare nr.
 	<p>SIRAI 2/2 vejs 1/2" <u>24V DC</u> magnetventil m/spole</p> <p>(Vandventil)</p> <p>Løs Spole t/SIRAI <u>24V DC</u> magnetventil</p> <p>Til model <i>L182B01ZB12A23</i></p>	<p>L182B01ZB12A23</p> <p>ZB12A-24V</p>
 	<p>SIRAI 2/2 vejs 1/2" <u>230V 50-60Hz</u> magnetventil m/spole</p> <p>(Vandventil)</p> <p>Løs Spole t/SIRAI <u>230V 50-60Hz</u> magnetventil</p> <p>Til model <i>L182B01ZB12A2</i></p>	<p>L182B01ZB12A2</p> <p>ZB12A-230V</p>
 	<p>SIRAI 2/2 vejs 3/4" <u>24V DC</u> magnetventil m/spole</p> <p>(Vandventil)</p> <p>Løs Spole t/SIRAI <u>24V DC</u> magnetventil</p> <p>Til model <i>L182B01ZB12A33</i></p>	<p>L182B01ZB12A33</p> <p>ZB12A-24V</p>

## 4-40-3

## Magnetventiler

### Vandventiler

Varegruppe 435

Billeder.	Beskrivelse.	Vare nr.
 	<p>SIRAI 2/2 vejs 3/4" <u>230V 50-60Hz</u> magnetventil m/spole</p> <p>(Vandventil)</p> <p>Løs Spole t/SIRAI <u>230V 50-60Hz</u> magnetventil</p> <p>Til model <i>L182B01ZB12A3</i></p>	<p>L182B01ZB12A3</p> <p>ZB12A-230V</p>
 	<p>SIRAI 2/2 vejs 1" <u>24V DC</u> magnetventil m/spole</p> <p>(Vandventil)</p> <p>Løs Spole t/SIRAI <u>24V DC</u> magnetventil</p> <p>Til model <i>L182B01ZB12A43</i></p>	<p>L182B01ZB12A43</p> <p>ZB12A-24V</p>
 	<p>SIRAI 2/2 vejs 1" <u>230V 50-60Hz</u> magnetventil m/spole</p> <p>(Vandventil)</p> <p>Løs Spole t/SIRAI <u>230V 50-60Hz</u> magnetventil</p> <p>Til model <i>L182B01ZB12A4</i></p>	<p>L182B01ZB12A4</p> <p>ZB12A-230V</p>

**4-40-4**

**Skråsædeventil**  
**Sektionsventiler**

Varegruppe 435

Billeder.	Beskrivelse.	Vare nr.
	Gemü Skråsædeventil 1/2" messing	554/15D195-1-1 1/2"
	Gemü Skråsædeventil 3/4" messing	554/20D195-1-1 3/4"
	Gemü Skråsædeventil 1" messing	554/25D195-1-1 1"
	Gemü Skråsædeventil 1 1/4" messing	554/32D195-1-1 1 1/4"
	Gemü Skråsædeventil 1 1/2" messing	554/40D195-1-1 1 1/2"
	Gemü Skråsædeventil 2" messing	554/50D195-1-1 2"
	Gemü Skråsædeventil 2 1/2" messing	554/60D195-1-1 2 1/2"

**4-41-1**

**Skråsædeventil**  
**Sektionsventiler**







Varegruppe 435

Billeder.	Beskrivelse.	Vare nr.
	Gemü Skråsædeventil 2" rustfrit stål (Tryk over sæde)	554/50D-137-51-4 2"
	Gemü Skråsædeventil 2" rustfrit stål (Tryk under sæde)	554/50D-137-51-1 2"
	Monteringsset for Gemü Skråsædeventil  Indeholder: Nippel - Pakninger - Magnetventile	554/KITSÆT
	SIRAI 3/2 vejs magnetventil 24V DC Passende for Gemü Skråsædeventil <b>(Normalt/Spændingsløs lukket)</b>	L372V01C-ZB12A
	Kabelstik med 0,5 m ledning Passende for SIRAI magnetventil	100022M
	PP 2-Vejs 2,5" kugleventil Luftstyret Passende for Big Dutcman	DE1004
	Rub 2" kugleventil Med InterApp aktuator Passende for Datamix	S.6400-2"

**4-41-2**





## Magnetventiler & Fittings

Varegruppe 435

Billeder.	Beskrivelse.	Vare nr.
	T-forskruning, klemstik 8mm x udv. M5 x 8mm, drejbar, forniklet, u/gevindpakning	C18508
	T-forskruning, lynstik 6mm x udv. M5 x 6mm, drejbar, kunststof, m/gevindpakning	E405068
	T-forskruning, lynstik 8mm x udv. M5 x 8mm, drejbar, kunststof, m/gevindpakning	E405088
	T-forskruning, lynstik 6mm x udv. 1/8" x 6mm drejbar, kunststof m/gevindpakning.	E408067
	T-forskruning, lynstik 8mm x udv. 1/8" x 8mm drejbar, kunststof m/gevindpakning.	E408087
	T-forskruning, lynstik 8mm x indv. 1/8" x 8mm, drejbar, kunststof, m/gevindpakning.	E418080
	T-stykke, lynstik 8 x 8 x 8mm, kunststof	E700080
	Samlestykke, lynstik 6mm, kunststof	E500060
	Samlestykke, lynstik 8mm, kunststof	E500080

## Magnetventiler & Fittings

Varegruppe 435

Billeder.	Beskrivelse.	Vare nr.
	Overgangnippel, lynstik 6mm x 1/8" udv.forniklet, m/gevindpakning.	108068
	Overgangnippel, lynstik 8mm x 1/8" udv.forniklet, m/gevindpakning.	108088
	1/8"X1/4" reduktion brystnippel, forniklet	S11840
	1/4" nylon pakning	266N-1/4X1,5
	1/8" nylon pakning	266N-1/8X1,5
	5mm nylon pakning	266N-M5X1
	Slange 6/4mm Polyethylen natur i 50m rulle	PE6/4NATUR
	Slange 8/6mm Polyethylen natur i 50m rulle	PE8/6NATUR



## Membranventiler

### Flexventiler

Varegruppe 436

Billeder.	Beskrivelse.	Vare nr.
	Flex Sektion/Membranventil Ø63mm limemuf,  incl. magnetventil Type A55/DN50	101471
	Flex magnetventil <u>24V DC</u>	1901500
	Overdel til Flex vådfodringsventil Type FL32/DN50  (Ventil 101471/101476)	1901107
	Membran  Firkant model, 4 huller  (ny model høj)	31606
	Underdel til Flex Sektion/Membranventil Ø63mm limemuf,  Type A55/DN50	1901110

**4-44-1**

## Membranventiler

### Flexventiler

Varegruppe 436

Billeder.	Beskrivelse.	Vare nr.
	Flex Vådfodringsventil Ø63mm limemuf,  incl. magnetventil Type A55 90gr./DN50	101476
	Flex magnetventil <u>24V DC</u>	1901500
	Overdel til Flex vådfodringsventil  Type FL32/DN50  (Ventil 101471/101476)	1901107
	Membran  Firkant model, 4 huller  (ny model høj)	31606
	Underdel til Flex vådfodringsventil Ø63mm limmuffe  Type A55 90gr./DN50	1901109

**4-44-2**

## Membranventiler

### Flexventiler



Varegruppe 436

Billeder.	Beskrivelse.	Vare nr.
	<p>Flex Vådfodringsventil kpl. Ø63mm limmuffe</p> <p>incl. magnetventil</p> <p>Type A55 90gr./DN50</p> <p>Passende for D-Mix &amp; Funki</p>	101480
	<p>SIRAI 3/2 vejs magnetventil <u>24V DC</u></p> <p><b>(Normalt/Spændingsløs åben)</b></p>	L372V01A-ZB12A
	<p>Overdel til Flex vådfodringsventil Med 1/4" RG</p> <p>Type DN50</p> <p>(Ventil 101480)</p>	1901108
	<p>Membran</p> <p>Firkant model, 4 huller</p> <p>(ny model høj)</p>	31606
	<p>Underdel til Flex vådfodringsventil Ø63mm limmuffe</p> <p>Type A55 90gr./DN50</p>	1901109

**4-44-3**



## Varmelamper

Varegruppe 455

Billeder.	Beskrivelse.	Vare nr.
	Varmelampe Ø210mm uden sparekontakt alm. 220V stik, 2,5m kabel	401
	Varmelampe Ø210mm med sparekontakt alm. 220V stik, 2,5m kabel	406
	Varmelampe Ø210mm uden sparekontakt, langt net, CEE 220V stik, 5,0 m kabel	417DK

## Varmepærer

Varegruppe 456

Billeder.	Beskrivelse.	Vare nr.
	100 W Rød Flex Varmepærer (20 stk. ks/kun i hele kasser)  eks. afgift	100WR
	150 W Rød Flex Varmepærer (20 stk. ks/kun i hele kasser)  eks. afgift	150WR
	100 W Rød Flex Lavenergi varmpære (24 stk. ks/kun i hele kasser)  eks. afgift	100PAR